

650^{cc}



USER MANUAL

X-RIDE



Congratulations !

You are the happy new owner of a MASH which embodies a new spirit, a new trend : a motorcycle with a look and a philosophy «Vintage», synonymous of freedom.
Please read this manual thoroughly before using your MASH.

Have a nice road !

Important Cautions

About running-in of a motorcycle

The first 1000 km operation is very important in the entire service life of a motorcycle. A correct running-in can guarantee both the longest service life and the best performance of the vehicle. Running-in can polish machined surfaces and form smooth engagement.

Careful and patient running-in can make the motorcycle stable in driving and give a full play to its excellent performance. It is important not to do any operation that may cause overheat to engine components.

For specific running-in method, please refer to «Running-in of a new vehicle».

Please carefully read the manual and strictly observe all instructions or descriptions.

Special Caution shall be paid to the contents emphasized with the terms of «warning» «caution» and «note»,

⚠ Warning : It concerns with personal safety. Ignoring it may result in accident.

⚠ Caution : It refers to operational methods that must be followed or measures that should be taken, so as to prevent damage.

Note : It refers to special explanations to make maintenance or important descriptions more explicit

The operation manual shall be deemed as a permanent document of the motorcycle. When transfer the vehicle to others, the instruction manual shall also be transferred to the new owner

Slight variations can however be observed between the models, composing the range. If this manual mentions details that are different from the actual model, do not consider them.



CHASSIS NUMBER

ENGINE NUMBER

DISTRIBUTEUR

Chassis number (or VIN code) and engine number is necessary for registration of your motorcycle. Such numbers are needed with order components or service, to allow the distributor to provide you with better service.

Chassis number (or VIN code) is on the riser pipe of chassis. Engine number is on the left side of crankcase. Metal nameplate is on the riser pipe of chassis, showing the main technical parameters, manufacturer and date of production of the motorcycle.

Write the numbers in the spaces below, for future reference.

Foreword

Congratulations on your choice!

If riding a motorcycle is one of the most exciting hobbies. This vehicle is also an ideal means of transport, which guarantees you unlimited driving pleasure. Before driving, you are encouraged to familiarize yourself with the instructions and specifications in this instruction manual, which describes in particular the rules for using and maintaining the vehicle.

Observing the following recommendations will ensure the reliability of your motorcycle and prolong its life.

The staff of MASH authorized dealers (list available by consulting the website www.mash-motors.fr) have the skills and technical qualifications required to carry out maintenance and provide quality service.

Contents

I	Main technical data.....	8
II	User Instruction	10
III	Installation position of parts.....	12
IV	Ignition switch.....	14
V	Control system.....	16
VI	Essentials of driving.....	18
VII	Controls and setting.....	23
VIII	Inspection and maintenance.....	29

I - Main Technical Data

Mash X-Ride 650cc Euro 5

MOTEUR	Engine Type	4T single cylinder, air-cooled
	Engine Capacity	644cc
	Compression Ratio	8.3:1
	Idle speed	1500±100RPM
	Power max	39.3 hp/6000 rpm (29kW)
	Torque max.	49.2N.m/4500 rpm
	Ignition	ECU
	Transmission	Chain
AUTRES	Gearbox	5 speeds
	Spark plug	DPR8EA-9
	Battery	12V 14Ah
	Oil Engine	SAE10W-40
CHÂSSIS	Oil Engine quantity	2500ml
	Front tyre	120/70-17
	Rear Tyre	150/60-17
	Front Brake	∅ 320 mm disc, 4-piston radial caliper
	Rear Brake	∅ 240 mm disc, single piston caliper
DIMENSIONS	Brake	Switchable ABS
	Length /Width /Height	2080 x 870 x 1200mm
	Saddle Height	780mm
	Wheelbase	1470mm
	Ground clearance	300mm
	Weight in running order	177kg
	Weight max	315kg
CONSUMMATION	Fuel tank capacity	11 liters
	Speed max.	150 km/h
	Fuel	SP95 or SP98
	Consumption	4.2L/100km
	Co2 emission index*	95g/km
	Norme	EURO 5

This list is for information only. Modifications can be made by the manufacturer without notifying customers. Non-contractual photo.

*The fuel consumption values are taken under specific test conditions and are provided for comparison purposes only. They may not match the values in actual driving use.



II - User Instruction

This user's manual describes the standard and safety method as well as basic maintenance. Read it carefully.

The images and illustrations in this manual may differ from those of your vehicle, if it is not the same model. The vehicle is designed for 2 people (driver included).

Caution

Do not use poor quality fuel.

Using poor quality fuel can cause deposits in the tank, which could block the fuel line and cause engine start-up failures or even serious engine damage.

Do not use inferior or poor quality motor oil. Always use a good quality engine oil to ensure engine performance and longevity. Any problem that appears due to the improper use of oil or gasoline cannot be covered by the warranty.

Protective Clothing

- Appropriate regulatory protective clothing, such as an approved helmet with a protective mask, approved gloves, high boots, must be worn while driving to ensure your personal safety.
- Loose clothing is not suitable for riding a motorcycle as it can get caught in the control levers, kickstarter, footrest or wheel.
- Always wear an approved helmet, approved gloves, high boots, a jacket.
- Drive carefully while always respecting the highway code
- Beware of the silencer which can be hot while driving.
- Always wear clothing that covers the whole body.
- **The above instructions are also intended for the passenger.**

Preparation before use

- Read the user manual carefully
- Maintain and check the vehicle before using it
- It is necessary to have the driving license corresponding to your vehicle and that it is insured
- Keep the engine off and away from any source of heat
- There are harmful substances such as carbon dioxide in the exhaust gases, always start the engine in a ventilated area
- Always wear an approved helmet, approved gloves, high boots, a jacket.
- Many traffic accidents between cars and motorcycles happen because the drivers do not see the bikers: always be vigilant!
- Make sure you are always visible to avoid accidents caused by others
- Wear bright or reflective clothing
- Always drive in the line of sight of other road users. Do not stay in the blind spot
 - Be particularly careful when approaching intersections. Always anticipate the reactions of other road users.

Caution

- **Not wearing a helmet increases the probability of fatal hurts in an accident**
- **Make sure the passenger always wears a full face helmet and protective clothing.**
- **Not to be in an abnormal state, anxious or excited. The driver's actions are very important for safe driving. Always sit in the middle of the saddle and especially not sit on the back of the saddle, this will lighten the weight in the front and cause the handles to shake.**
- **The passenger must hold the pilot and put his feet on the rear footrests.**
- **To turn, point your body to the side where you turn, otherwise it can be dangerous.**
 - **Driving on a winding and uneven road means that you absolutely must respect the safety instructions.**
 - **Driving on a winding and uneven road involves halving the speed, relaxing the shoulders and waist and squeezing the handles.**
 - **To drive, you must squeeze the handles with both hands, do not try to lift the front wheel, this facilitates overturning and causes serious accidents.**

III - Installation position of parts

Handle bar instrument

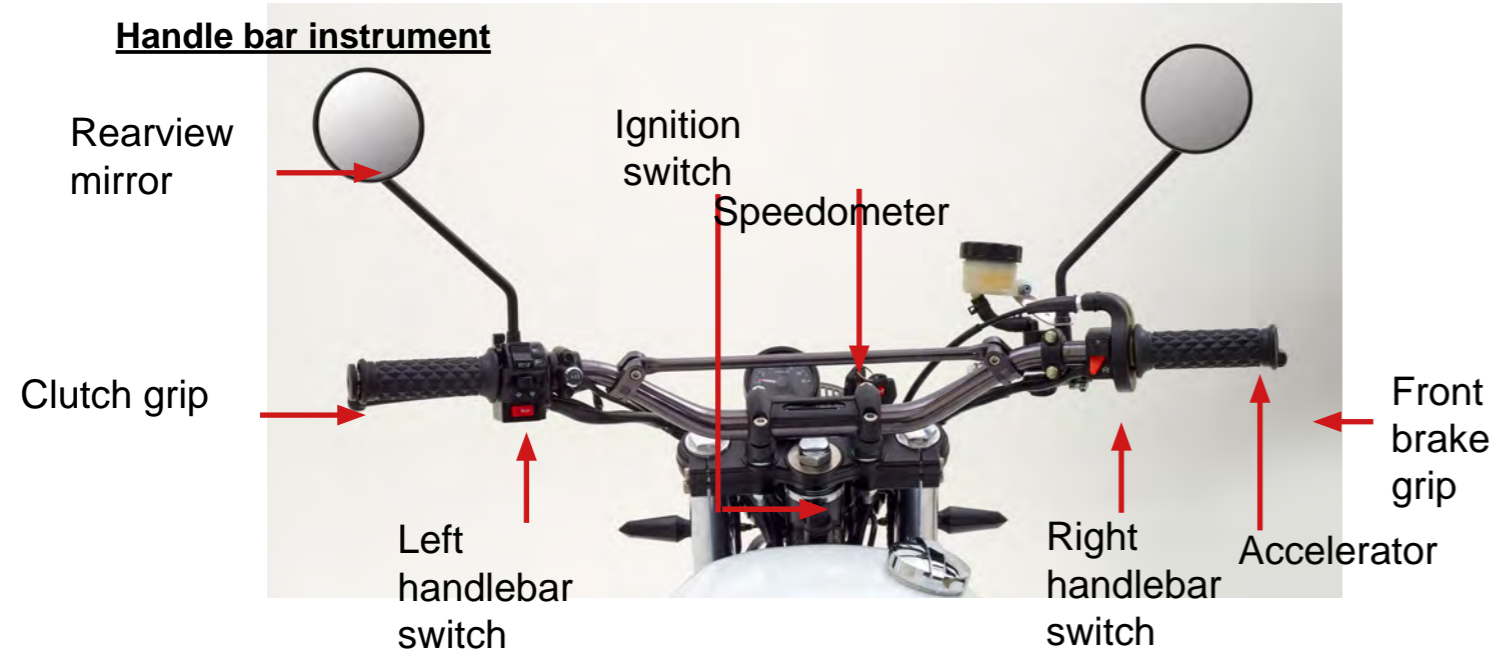

Left side



Right side

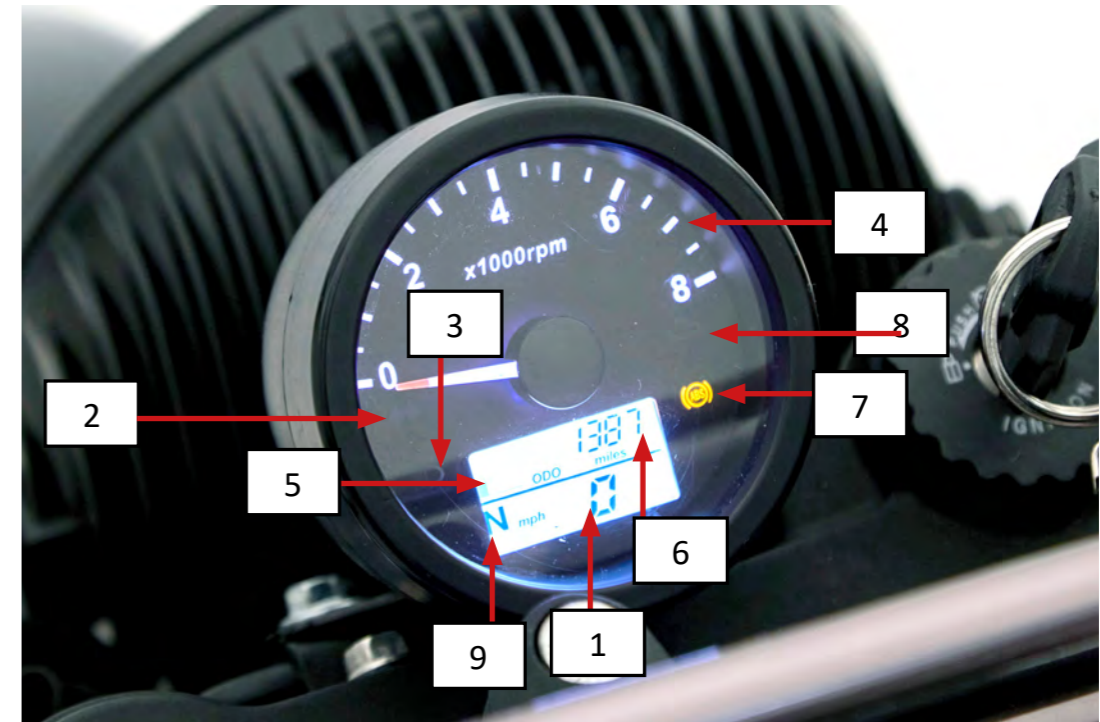



Use and reading of the meter

- 1. Speedometer** : Indicates the speed of the motorcycle (Km/h). Do not exceed the maximum allowed speed.
The passage from Miles to Km/h is done after 2 quick activations of the key switch: ON→OFF→ON→OFF. Then wait 10 seconds
- 2. Turn signal indicator** : Flashes when a turn signal is activated
- 3. High beam indicator lamp**
When the head light is in high beam, the indicator is lit.
- 4. Tachometer** : Indicates engine speed (tachometer)
- 5. Fuel level indicator** : Indicates fuel level
- 6. Total odometer**
Indicates total mileage (ODO)
The passage from Miles to Km is done after 2 quick activations of the key switch: ON→OFF→ON→OFF. Then wait 10 seconds
- 7. ABS warning light**
When the ABS system is activated, the warning light is off. Comes on when there is an engine malfunction. If this warning light comes on on the speedometer, it is necessary to go to a retailer.
- 8. Engine Light**
Comes on when there is an engine malfunction. If this warning light comes on on the speedometer, you must go to an authorized Mash dealer in order to carry out a diagnosis.
- 9. Neutral light**: Comes on in neutral

IV - Ignition switch

The ignition switch controls the ignition and lighting circuits and allows the steering to be locked. Its various positions are described below.

Position	Fonction
	Position (OFF) All circuits are off: the key can therefore be removed.
	Position (ON) All electrical circuits are live: the engine can therefore be started. The key, however, cannot be removed.
	To lock the steering, turn the handlebars to the left, insert the key, push and turn it to the left until the steering lock logo



Caution

Do not change the position of the key while driving.

The engine and motorcycle must be stopped before removing the key.

Headlights - Position indicator

Turn the main ignition key to position , the headlights come on automatically.



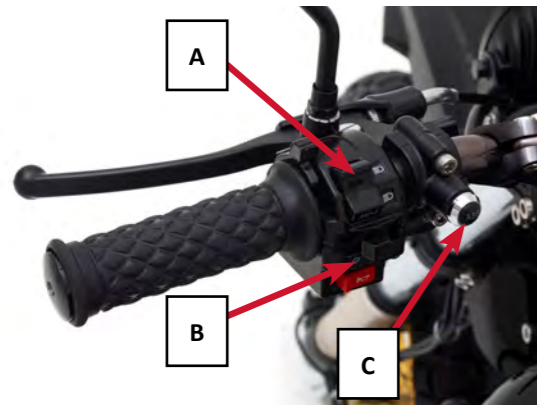

V - Control system

Left handlebar control system



Dimmer switch A



Press the button, using the switch allows you to choose the distance of the headlights : high or low.

-  High beam
-  Low beam

Turn signal switch B

Use the turn signals to turn left or right.

Operate the button to the left or to the right, the indicator will flash. Press the switch again to stop the turn signal.

-  (R) Turn right
-  (L) Turn left

ABS button C

A switch on the left stalk switch disconnects the ABS system. By default, ABS is always on. However, it is possible to deactivate it if you wish. The ABS warning light will flash continuously on the dashboard.

ABS deactivation:

Ignition on or engine running, press the ABS button, as soon as the ABS warning light comes on, switch the switch to «ABS». The ABS light now flashes to let you know that is disconnected. The ABS reactivates after an engine cut.

Caution

When you are finished turning, the turn signals do not turn off automatically. You have to press this button to stop them.

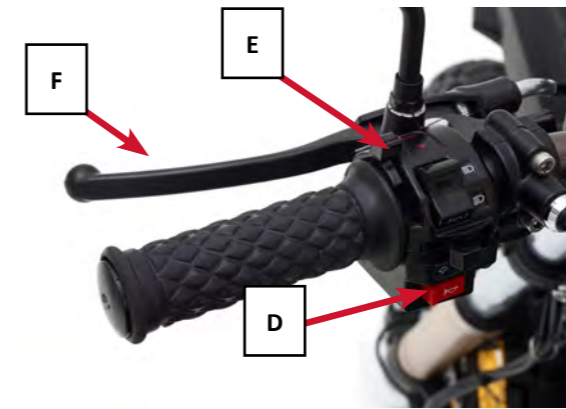

Horn Button D

Turn the key switch to the ON position, press the horn button and it will emit a sound

Headlight flasher switch E

The flasher can be used to signal its presence.

Clutch grip F

Allows the motor to be disengaged in order to change gears.

Right handlebar control system

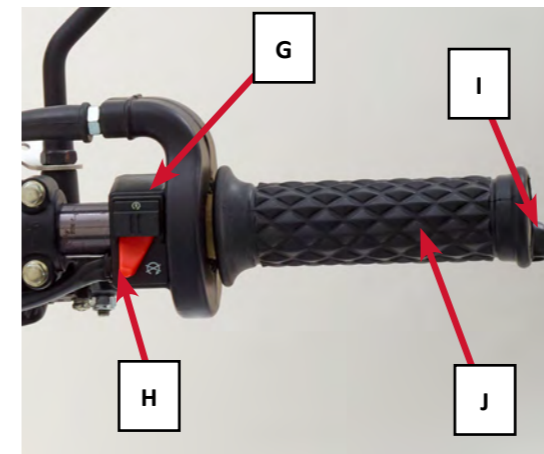

Electric starter button G

Press this button to start the engine.

Caution

Make sure that the vehicle is always in neutral position (N or 0) and always operate the clutch grip before starting the engine

Engine shutdown switch H

It is used to manually stop the motorcycle in an emergency situation.

Position it on  to be able to start the engine.

Front brake grip I

To apply the front brake, gradually press the brake grip located on the right handlebar. Since the motorcycle is equipped with hydraulic braking, the brake lever should not be manipulated either sharply or roughly. Pressing the lever automatically turns on the brake light.

Accelerator grip J

It makes it possible to vary the speed of rotation of the motor. The acceleration is done by making it turn towards you; deceleration, by releasing the handle.

Caution

Only use the emergency stop switch in an emergency situation.

VI - Essentials of driving

Fuel tank cap

To open the tank cap, insert the key and turn it clockwise. The cap can then be removed with the key. To replace the cap, exert pressure on the cap and remove the key.



Fuel

Gas up

The fuel tank capacity is 11L. To fill your vehicle's fuel tank, put it on the main stand, open the fuel cap with the key and fill with fuel through the opening, then close the cap and remove the key.

- 1 Fuel level
- 2 Filling tube

⚠ Caution

The motorcycle is equipped with a fuel vapor recirculation system, do not overfill the tank.

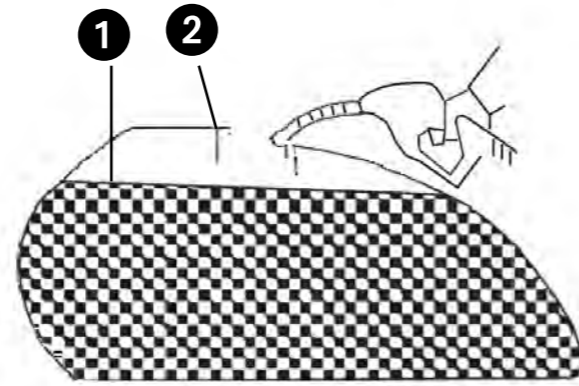

⚠ Warning

Do not overfill the reservoir. Never spray fuel on a hot engine. Fill the tank to the lower level of the filler tube, otherwise fuel may overflow and expand with increased temperature.

Turn off the engine and turn the key to the OFF position when filling the tank. It is strictly forbidden to smoke or light a fire during this operation.

Starting the engine

Turn the key switch to the ON position. Make sure the emergency stop switch is in the ON position.

Make sure the gearbox is in neutral (N or 0) by checking that the neutral indicator light is on.

Make sure there is gasoline in the tank.

⚠ Caution

Make sure that the vehicle is always in neutral position (N or 0) and always operate the clutch lever before starting the engine

To start the engine

Make sure that the key switch and the emergency stop switch are in the «» position, that the gearbox is in neutral (neutral) and always operate the clutch grip.

To start, press the electric starter button. Never turn the throttle at the same time.

If the engine does not start, stop pressing the start button after 5 seconds and wait more than 5 seconds before restarting.

Twist the throttle slightly about 1/8 of a turn, but never more than 1/4 of a turn to increase the air intake and start the engine.

If the engine starts, but stalls while idling when it is cold, run the engine at a slight throttle, for 10 seconds or more, to warm it up.

Note: After starting the engine, immediately release the starter button to avoid damaging the engine.

⚠ Warning

Get in the habit of engaging neutral and pressing down firmly on the clutch lever before starting the engine: this helps prevent being thrown forward if the wrong gear is engaged.

Never start the engine in a poorly ventilated or poorly ventilated room: carbon monoxide emissions are indeed toxic. Never leave the motorcycle with the engine running unattended.

⚠ Caution

Do not let the engine run for an extended period without driving: the overheating which could result will damage the mechanical parts and the chrome coating of the exhaust.

Gear change

1. When stopped, with the engine at idle speed, disengage and press the selector with your left foot to shift from neutral to first.

2. When the motorcycle stabilizes, bring the throttle back and disengage the clutch again, then raise the selector to go into second.

3. Proceed in the same way to go from the 3rd, 4th & 5th

⚠ Caution

Do not depress the gear selector instead of raising it while driving, you risk downshifting and causing the engine to over-speed.

Downshift

If you want to accelerate sharply, for example to overtake, downshifting can cause faster acceleration, but if the rpm gets too high it can damage the engine.

At high speeds, downshifting can cause the engine to over-rev. Before engaging a lower gear, it is necessary to slow down to avoid any engine damage.

Monter les rapports

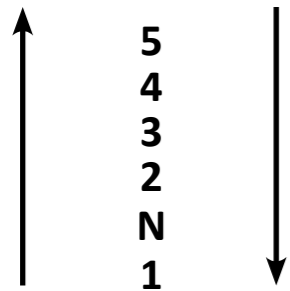

Descendre les rapports



⚠ Caution

When you shift into neutral, the neutral indicator light (N or 0) comes on on the instrument cluster (if equipped). Even if the light is on, gradually release the clutch lever to make sure the transmission is in neutral.

Functioning

- Before starting the engine, make sure that the sidestand is fully folded up.
- If you cannot easily move the sidestand, check that the kickstand is lubricated.
- Change gear appropriately in relation to engine speed.
- To consume little fuel and ensure the longevity of your machine, do not drive at high speed and favor low and medium speeds.

Break-in

Running 1000 km of break-in at a speed not exceeding 6000 rpm will improve engine life.

⚠ Caution

- **Always start the vehicle first and start as gently and carefully as possible.**
- **If you hear any abnormal noise while driving, contact a MASH dealer to have it checked.**
- **Never exceed the authorized speed.**

Brake

- Use the front brake and the rear brake simultaneously.
- Avoid braking suddenly if it is not necessary.

⚠ Caution

- **If you only use the front or rear brake, the motorcycle could slip.**
- **If you are riding in rainy weather or on a wet road, braking suddenly can cause accidents, adjust your speed according to the conditions and use the brakes appropriately.**
- **Braking repeatedly causes the brakes to overheat and reduce their effectiveness.**

Engine brake

The motor can act as a brake during deceleration. If you want to brake harder, we suggest you downshift, being careful not to over speed the engine. However, if you need to bring the motorcycle to a quick stop, you can use the brake and engine brake at the same time.

⚠ Caution

When the motorcycle is being driven at high speed, do not downshift immediately, it may suddenly reduce the speed and damage the engine and transmission system, and even block the rear wheel of the vehicle.

Parking

- Position the gearbox in neutral (N or 0) and turn off the engine.
- Use the side stand to keep the motorcycle stable and park it on level ground, otherwise it will fall. The vehicle is fitted with a side stand. To immobilize the vehicle using the side stand: press the end of it with your foot to fully unfold it.

⚠ Caution

- **Park the motorcycle in a safe place where there is no traffic.**
- **Always park the motorcycle on a level and stable surface.**
- **The silencer can be very hot, do not park your motorcycle in a place where there are traffic, there is a risk of burns.**
- **If you park the motorcycle on a slope, stop it uphill to prevent it from descending.**
- **To drive in complete safety, check before resuming the road that the stand side is fully raised and remains perfectly in place.**

Parking and using the steering lock

Place the motorcycle on level ground and put on the side stand.

Then turn the handlebars to the stop on the left side and position the key switch in the steering lock position (padlock logo).

Remove the key from the switch, the handlebars are now locked in the parking position.

⚠ Caution

- **If the handlebars are turned to the right or if the motorcycle's side stand is incorrectly positioned, the vehicle may fall.**
- **In unavoidable situations, adequate measures must be taken to ensure stability.**

Mirrors

Before driving, always adjust your mirrors.

⚠ Warning

Do not put anything in the rear seat so as not to obstruct visibility in the mirrors.

Do not adjust your mirrors while driving.

⚠ Caution

To clean your mirrors, use a soft cloth. Use a suitable cleaning product without putting it directly in contact with the mirrors.

Shock absorbers

Rear Shock Spring Preload

The spring preload of the rear shock absorber 1 can be adjusted; to make the setting, do the following:

- Remove any residue that could damage the threads of the shock body.
- Loosen lock nut 2 using a suitable spanner.
- Turn the adjusting ring nut 3 if necessary.
- When the adjustment operation is complete (depending on your weight and riding style), tighten the lock nut.

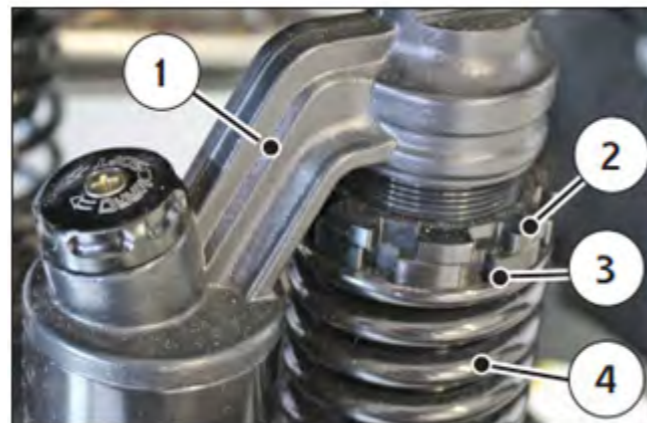

VII - Controls and setting

Running-in

The importance of a good running-in of the new vehicle has been stressed in the Foreword and presupposes compliance with the rules set out below.

Maximum speed

The maximum speed during the various running-in stages is given in the following table.

During the first 1000 kilometers, the throttle grip should be turned to a maximum of 70%.

Change of engine speed

Do not ride for too long at a constant speed. Vary the engine speed to complete the running-in. It is essential to change speed from time to time so that the moving parts of the engine undergo different stresses which will guarantee their correct adjustment: in fact, when the pressure exerted on them falls, they cool down and acquire the desired position. For the same reason, it is also strongly recommended to practice gentle revs during running-in, while taking care not to subject the engine to excessive stress.

Avoid driving too low or too high

Driving at low revs for long periods of time can cause engine and transmission jerkiness. The owner of the motorcycle is therefore encouraged to ride at the most varied speeds while refraining from accelerating too sharply and from cranking the engine to very high revs. However, it is strongly recommended not to accelerate fully during the first 1000 kilometers.

Let the oil circulate before riding

After starting the engine (hot and cold) and before setting off, let the engine idle for a period of time suitable for it to warm up properly. This allows the oil to spread over every part of the engine and do its part in reducing wear and improving its life, while bringing the engine to a suitable operating temperature.

First maintenance check

Maintenance is of critical importance during the first 1,000 kilometers. During the running-in, the engine parts, but also those of other parts of the vehicle, adjust gradually: once the break-in is complete, it is therefore necessary to check all the tightening and replace the old engine oil. and the oil filter.

Carrying out a maintenance check after the first 1000 kilometers helps to ensure engine longevity and best performance.

Lubricant

By using a high quality lubricant suitable for a four stroke engine, you will extend the life of your engine. Please select the type of high quality IPONE SAE10W40 lubricant.

Engine oil

Replacing the engine oil.

Engine oil plays an important role in the normal operation of the engine and for this reason it is necessary to check the engine oil periodically and to renew it after the first 1000 km and then every 3000 km according to the procedures. following.

Note : When draining, clean the gauge (if equipped) and replace the oil filter.

Engine oil change

Replacing the engine oil should be done while the engine is still warm to allow the fluid to drain completely.

To do this, proceed as follows:

1. Immobilize the motorcycle by placing it in a vertical position
2. Remove the oil filler cap
3. Unscrew the drain screw and let out the used oil
4. Replace the oil filter

Caution

Check carefully for leaks around the oil filter cover.

5. Tighten the drain screw and fill with new oil

The total engine oil capacity is 2500mL (engine dismantling)

Drain screw tightening torque: 20-30 Nm

6. Check the oil level using the gauge (if equipped) or the oil level sight glass.

Checking the oil level

Before each use of the vehicle, always check the oil level with the gauge or the oil level sight glass to make sure that the amount of oil is correct.

Caution

The use of inferior quality oil can permanently damage the engine and seriously shorten its life.

Pre-ride inspection

Before road, remember to check the following points. Never underestimate the importance of inspection.

Element	Control to be carried out
Handlebar	Ensure that direction is: - soft - free - no hard point in rotation
Lighting	Operate all lights (front light, rear light, front and rear brake light, instrument cluster lighting, turn signals)
Engine oil	Check the oil level
Brakes	- Adjust the «play free» of the rear brake pedal and the front brake lever - Ensure effective braking - Check for leaks
Indicator lights	Engine light, gear engaged, oil level, turn signals, high beam
Accelerator grip	- Check the tension of the accelerator cable - Check that there is no hard point or resistance in the rotation of the handle and that it returns to the initial position.
Tires	Check the tire pressure Check the depth of the tread patterns (wear) Check for nicks or cracks
Audible warning device (horn)	Ensure proper operation
Clutch	Check the tension of the clutch cable. Check its proper functioning and the effectiveness of the clutch
Fuel	Fill the tank with the correct fuel. Do not overfill the reservoir.
Transmission	Check the tension. Check lubrication

Rules of conduct

Warning

If this is your first time riding this type of motorcycle, we recommend that you familiarize yourself with its controls and operation on a low-traffic road until you have mastered it.

Before setting off, check that the sidestand is correctly raised.

Do not accelerate sharply or downshift in a turn or change of direction.

Slow down enough when braking before entering a turn.

It is dangerous to operate a motorcycle with one hand. When riding, always hold the handlebars firmly with both hands and keep your feet on the footrests. Never take both hands off the handlebars at the same time.

On wet roads, the friction force being low, the braking distance increases and it is more difficult to change direction: so remember to decelerate in advance.

Always respect traffic rules and speed limits

First turns of the wheel with the motorcycle

Caution

Start the engine with the transmission in neutral, the clutch engaged and the rider in the normal driving position.

Pass a gear report

Press down firmly on the clutch grip, wait a brief moment, lower the selector to engage first gear, gently turn the throttle toward you and slowly and smoothly release the clutch lever. The motorcycle begins to move when the clutch is gradually released.

To upshift, first accelerate slightly, then, releasing the throttle, pull the clutch lever, move the selector up with your left foot and release the clutch lever, before accelerating again. Proceed in the same way until the maximum gear.

Downshift to slow down

Before downshifting, it is necessary to start reducing speed by braking. As soon as the engine speed is sufficiently reduced, you can pull your clutch lever and then with your left foot depress the gear selector in order to downshift a gear. Then release your clutch lever gradually to use the lower gear engine brake.

Proceed in the same way until the minimum ratio.

Warning

Never downshift 2 gears at the same time, you risk damaging the engine if you over-speed.

Never release the clutch grip abruptly, as this may jerk or block the rear wheel momentarily.

Driving on a down hill

On a descent, you can pick up more speed than normal without accelerating. Use engine braking to stabilize your speed and brake to slow down when needed.

Before downshifting, slow down enough to avoid a sudden increase in engine speed, which could damage the transmission, increase wear on parts, and even unbalance the motorcycle while riding.

Warning

Remember never to go down a hill at too high a speed!

Driving uphill

When going up a steep hill, the motorcycle may decelerate. In this case, downshift immediately to bring the engine speed within the normal operating range. Be sure to change gear quickly to maintain its pace.

Warning

Never put excessive stress on the engine for an extended period of time.

Braking

Riders with little experience are usually content to use only the rear brake, which causes premature brake wear and increases the stopping distance. In addition, this would promote locking of the rear wheel and loss of control of the vehicle.

Therefore, it is strongly recommended that you do not use only one of the two brakes.

On wet roads or any other smooth surface, use extreme caution in gradually applying the brakes simultaneously. Abrupt braking on slippery, bumpy or smooth road surfaces is extremely dangerous. Always anticipate your braking in advance.

Warning

The greater the braking distance the faster the vehicle speed is. Be sure to correctly assess the distance to the vehicle or object in front of you to brake accordingly.

VIII - Inspection and maintenance

The following table specifies the periodic maintenance intervals expressed in distance traveled or number of months. At the end of each period, remember to perform the inspection, lubrication and maintenance. If the motorcycle is routinely operated at a high load (for example, heavy engine load in dusty areas), perform maintenance at regular intervals. Your dealer will give you additional maintenance advice. The components of the steering, shocks, bearings and wheels are essential to the operation of the vehicle and should only be maintained and repaired by qualified professionals. To ensure your safety, it is recommended that inspection and maintenance be performed by your authorized MASH dealer.

Caution

During periodic maintenance, it may be necessary to change one or more parts: these must be replaced by original parts. Regardless of your vehicle maintenance experience, items marked with the * symbol should be supported by your dealer and qualified service personnel. You can perform maintenance on items not marked with this symbol, provided you follow the instructions.

Warning

Once the vehicle has been broken in, maintenance is mandatory to ensure its safety and to fully exploit its performance.

Perform periodic maintenance in strict accordance with the recommendations given in this manual.

Please note that the maintenance interval is 3000kms.

Do not forget to have your periodic maintenance certified by your dealer in the maintenance sheets of your warranty booklet

PERIODIC MAINTENANCE CHART

Interval: According to the first deadline in Kilometers or number of months.	KM	1000	4000	7000	10 000
	Number of months	6	12	24	36
Battery	I	I	I	I	I
* Throttle valve, accelerator cable	I	I	I	I	I
* Spark plug	I	R	R	R	R
* Clutch	I	I	I	I	I
* Air filter	N	R	R	R	R
* Oil filter	N	N	N	N	N
* Fuel hoses	I	I	I	I	I
	To be replaced every 4 years				
* Engine oil and oil filter	R	R	R	R	R
* Oil filter strainer	N	N	N	N	N
* Valve clearance	I	I	I	I	I
* Distribution chain	I	I	I	I	I
* Chassis screws and bolts	S	S	S	S	S
* Braking, front / rear brake pads, linings	I	I	I	I	I
* Brake fluid	I	I	I	I	I
	To be replaced every 2 years				
* Brake hoses	I	I	I	I	I
	To be replaced every 4 years				
* Front fork	-	I	I	I	I
* Rear suspensions	-	I	I	I	I
Wheels and tires	I	I	I	I	I
Transmission channel	I	I	I	I	I
	Check the voltage every 1000 kms				
* Steering, bearings	I	I	I	I	I
* Exhaust and top engine mounting screws	S	S	S	S	S

Legend:

I: Carry out an inspection, cleaning, adjustment, tightening, lubrication or replacement.

N: Cleaning.

R: Replacement.

S: Tightening

* This item should be serviced by a MASH dealer

LUBRICATION CHART

Element	Interval	Every 3,000 km or 12 months	Every 6,000 km or 24 months
Throttle grip cable		Engine oil or (1)	Engine oil or (1)
Clutch cable		Engine oil or (1)	Engine oil or (1)
Tachometer cable		-	Grease (2)
Transmission channel		Lubricate every 1000 km (3)	
Axle, brake caliper piston		-	Grease (2)
Throttle grip		-	Grease (2)
Brake cable		Engine oil or (1)	Engine oil or (1)
Tachometer gearbox and wheel bearings		-	Grease (2)
Brake pedal, various axles, pivots		Grease or (1) (2)	Grease or (1) (2)
*Direction		To be lubricated every two years or every 6000 kms	

Reference IPONE : (1) Full Protect / (2) Waterproof Grease / (3) X-Trem Chain Road

Outillage

To facilitate regular maintenance of the motorcycle, a set of tools is available in the kit placed with the vehicle.

Battery

The battery is normally placed under the right rear fairing of the vehicle. Two models are available for this model: maintenance free or SLA (factory activated).

Respect the polarity of the battery by connecting the red wire to the positive (+) terminal and the black wire to the negative (-) terminal. Improper connection will damage the charging system and the battery.

Note : After the first 1000 km, then every 3000 km or every 6 months, have the capacity of your battery checked by your dealer.

⚠ Caution

Never damage, block or change the battery breather hose. Make sure that the breather hose is connected to the corresponding port on the battery and that its other end is not blocked or pinched. The breather hose and the battery must be installed correctly.

Spark plug

After driving the first 1000 km, then every 3000 km, clean the carbon deposits from the spark plug using a small wire brush or spark plug cleaner. Using a feeler gauge, adjust the gap between the electrodes, keeping a value between 0.6 and 0.8 mm. Replace the spark plug every 3000 km.

The carbon deposits having been removed, observe the color of the candle to see if it is suitable for its use. A wet or very dark standard candle means poor combustion with an overly rich mixture. A light gray or cotton yellow colored spark plug indicates good combustion and normal conditions of use. An extremely white spark plug, on the other hand, reflects poor combustion and overheating of the engine.

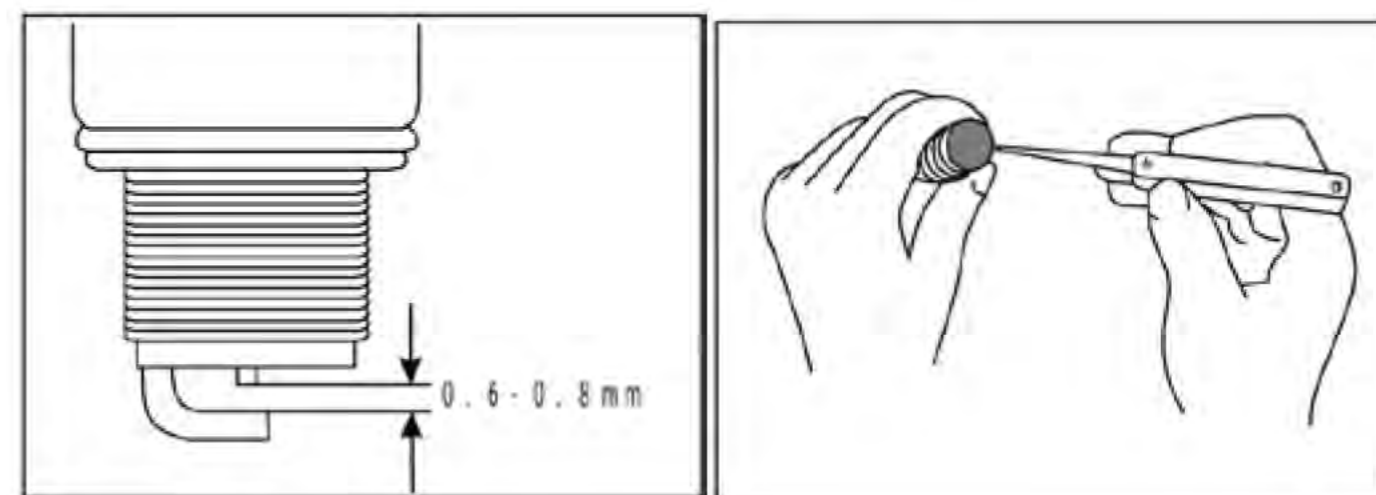

⚠ Caution

Do not overtighten the spark plug to avoid damaging the cylinder head threads. When removing it, prevent dirt from falling into the engine through the spark plug hole.

The original spark plug fitted to the motorcycle has been carefully selected to suit various operating conditions. If the color of the candle does not comply with normal conditions of use, we recommend that you contact your dealer.

As the choice of an unsuitable spark plug (for example from another manufacturer) is likely to seriously damage the engine, we therefore invite you to contact your dealer before choosing a product sold under another brand.

Note: When draining, clean the dipstick and replace the oil filter.

Engine oil change

Engine oil replacement should be done while the engine is still warm to allow the fluid to drain completely.

To do this proceed as follows:

1. Immobilize the motorcycle by placing it in a vertical position
2. Remove the oil filler cap
3. Unscrew the drain screw and drain the used oil
4. Replace oil filter

⚠ Caution

Carefully check for leaks around the oil filter cover.

5. Tighten the drain screw and fill with 2.5 liters of oil
The total engine oil capacity is 2.9L (engine disassembly)
- Drain screw tightening torque: 20-30 Nm
6. Check oil level

Checking the oil level

Before each use, always check the oil level to ensure that the amount of oil is correct.

- Warm up the engine to operating temperature
- Immobilize the motorcycle by placing it in a vertical position
- Stop the engine
- Check the oil level within a minute

Note: screw-in level control dipstick



⚠ Warning

When the engine is at operating temperature, the oil can be very hot, be careful not to burn yourself. Place the motorcycle on a flat surface, remove the cap, then fill the oil tank. Thoroughly clean the cap.

The dipstick must be replaced correctly otherwise it may not work properly and cause engine damage.

Oil filter replacement Remove the oil filter cover. Remove the used oil filter. Clean dirty oil before replacing new filter.

Idle speed

⚠ Warning

The engine of your Mash is fitted with a petrol injection system. It is therefore not possible to adjust the idle speed of this engine.



Accelerator handle

First, check that the throttle control grip is not bent, twisted or damaged. Then, measure the throttle cable free play. Turn the handle in order to press it on one side and measure the play between the 2 free movements of the handle. If the play is insufficient or too great, make an adjustment.

Tuning methods:

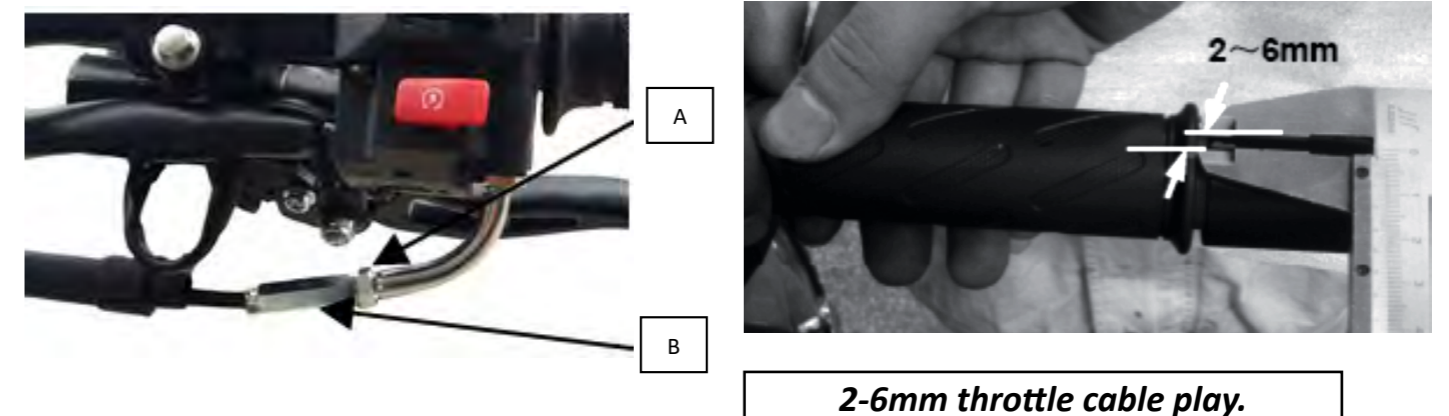

Fine Tuning:

Remove the protective rubber, unscrew the fixing nut A, and turn the adjustment nut B to obtain a satisfactory clearance. Then retighten the fixing nut A and put the protective rubber back in place.

Then check that the travel of the throttle grip is linear and satisfactory.

⚠ Caution

When the throttle cable free play has been adjusted, check for proper throttle grip operation. The setting will have no effect on the engine idle speed, and the handle will automatically return to the closed position.

Fork: functional checks

To check for proper front fork operation, do the following:

- Get on your motorbike.
- Pull the front brake lever and push the handlebar down several times to check that the fork extends and compresses correctly.
- If you notice oil leaks and blockages, contact your Mash dealer for service.

Side stand

Fold the stand, the motorcycle will be positioned. Check the correct operation of the spring and that it is not damaged, lubricate it if necessary.

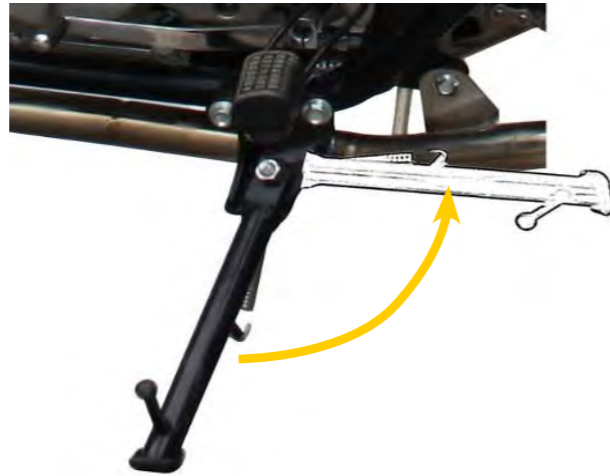

Brakes

ABS:

Your motorcycle is fitted with a system which limits the locking of the front wheel during periods of intense braking (ABS).

If the ABS warning light comes on on the speedometer, it is necessary to go to an authorized Mash dealer in order to carry out a precise diagnosis.

The front brake is equipped with a disc. Check the brakes after the first 1000 km, then every 3000 km. The proper functioning of the brakes is essential for driving safety. Have the brake system inspected periodically by the authorized distributor

Warning

Braking efficiency determines user safety and must be guaranteed at all times. The repair of the braking system or the replacement of the linings should preferably be entrusted to your dealer. The latter has in fact complete tools and proven techniques to carry out these operations in a way that is both economical and secure..

Front brake

If the motorcycle is equipped with a front disc brake, the play of the brake lever must be between 5 and 10 mm (measured at the level of the hood).

The hydraulic brake system should be checked daily, proceeding as follows:

1. Check for leaks in the front wheel brake circuit.
2. Check brake hose for leaks.
3. Check whether the front brake lever gives resistance when operated.
4. Check the state of wear of the front wheel brake linings

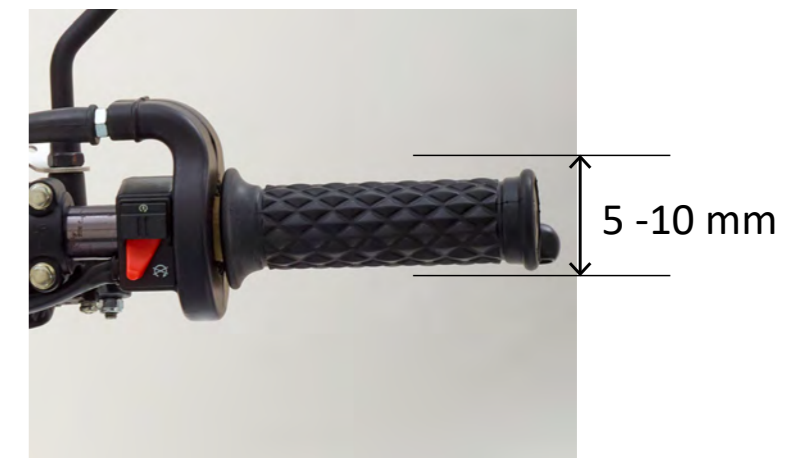

Caution

Disc brakes are part of a high pressure system. For your safety, the hydraulic oil replacement interval should not exceed the interval specified in the periodic maintenance table in the manual.

Rear brake

Adjusting the rear wheel brake

The rear brake is a disc brake. To adjust the rear wheel brake pedal, bring the pedal to the most comfortable driving position by turning the clamping nut (1). Once the position has been adjusted, lock it using the lock nut (2). Please maintain a clearance of between 10 and 20 mm (3).



Regularly check the condition of the brake pads. The thickness of the filling must be greater than 2 mm. If the latter is less than 2mm, the brake pads must be replaced.



Degrease the rear brake disc at regular intervals to guarantee optimum braking quality at all times.

In the event of a brake fluid leak, contact your MASH dealer.

In the event of a braking problem, contact your MASH dealer.

Brake fluid type: DOT4

Brake pads

Checking the pad linings is mainly limited to checking their state of wear. The pads must be replaced if they are worn to the bottom of the groove (if equipped), which acts as a mark.

Warning

Do not ride immediately after changing pads. Press the brake lever several times to position the pads against the disc.

Brake fluid level

Place the motorcycle on a flat surface, activate the front brake lever and check that the level is well placed between the two lines.

If the brake fluid level drops rapidly, a leak may be the cause and your authorized Mash repairer should be repaired quickly.

The proper functioning of the brakes is essential for driving safety. Have the brake system periodically inspected by your authorized MASH dealer.

Caution

• Brake fluid should not exceed the upper level mark to avoid overflow.

• Do not allow dust or water to enter the master cylinder.

• Preferably use the same supplier for the brake fluid in order to avoid chemical reactions between the types of fluid. Take care that the brake fluid does not come into contact with the parts of the vehicle, this would damage the painted parts.

Topping up brake fluid

• Ensure that the master cylinder is in a horizontal position.

• Wipe dust and any foreign particles from the master cylinder. Unscrew the master cylinder cover screw and remove the diaphragm.

• Add the recommended quantity of brake fluid up to the upper limit, then retighten the master cylinder cover securely, taking care to replace the diaphragm correctly to prevent any foreign bodies from entering the master cylinder.

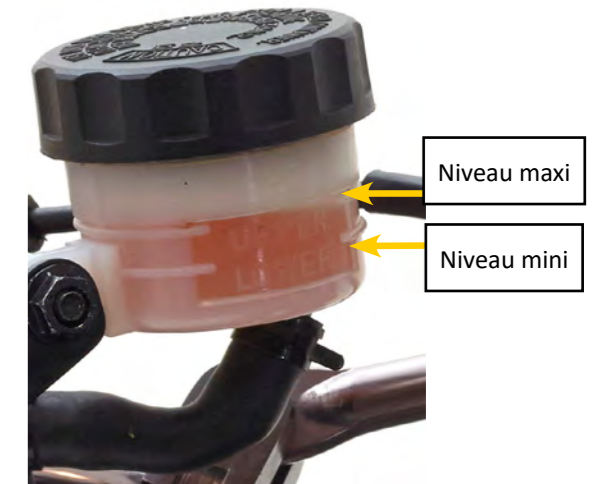

Maître-cylindre avant

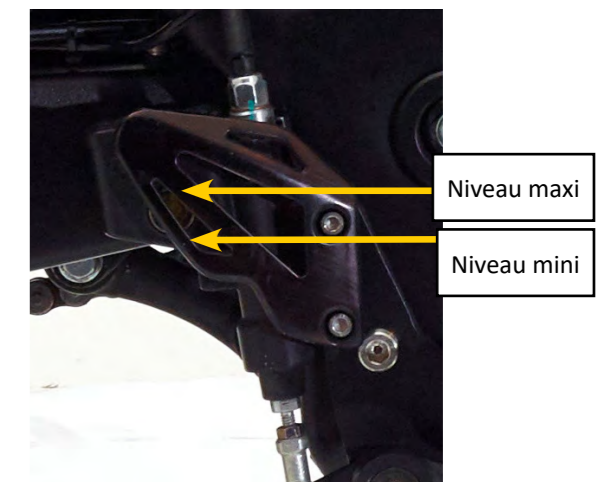

Maître-cylindre arrière

Caution

Ipone reference: brake dot 4

Brake fluid should not be mixed with impurities, otherwise braking performance will be reduced due to change in chemical properties.



Warning

Brake fluid is poisonous. In case of accidental ingestion, spit it out vigorously. In case of contact with skin or eyes, rinse thoroughly with clean water and consult a doctor immediately.



Caution

Brake fluid is particularly corrosive, never spill it on painted surfaces or plastic parts.

Checking the front and rear brake pads

Inspection of the linings is essentially limited to checking their state of wear by comparing their thickness with the groove forming a mark. The packing must be replaced if it is worn down to the bottom of the groove.



Front brake caliper

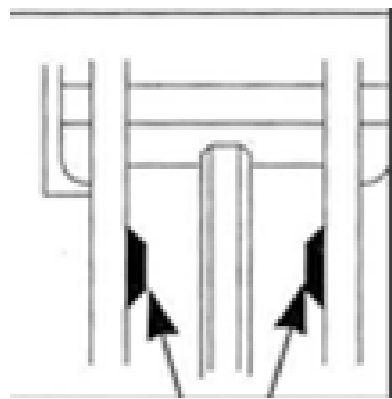

Wear indicator

Regularly check the condition of the brake pads. The thickness of the lining must be greater than 2 mm, if the thickness is less than 2 mm, provide for replacement

Degrease the brake discs at regular intervals to guarantee optimal braking quality at all times.



Rear brake caliper

Exhaust pipe

It is advisable to stay away from the exhaust pipe after a long journey to avoid any risk of burns



Air filter

Clogging of the dust-saturated air filter can reduce engine power and increase fuel consumption. It is therefore important to check its condition and clean it every 3000 km. To do this, observe the following procedure:

1. Remove the right side fairing.
2. Unscrew the outer screws of the air filter cover (1) and remove the air filter sleeve (2).
3. Remove the air box cover in which the air filter foam is located.
4. Separate the foam from the air box cover.

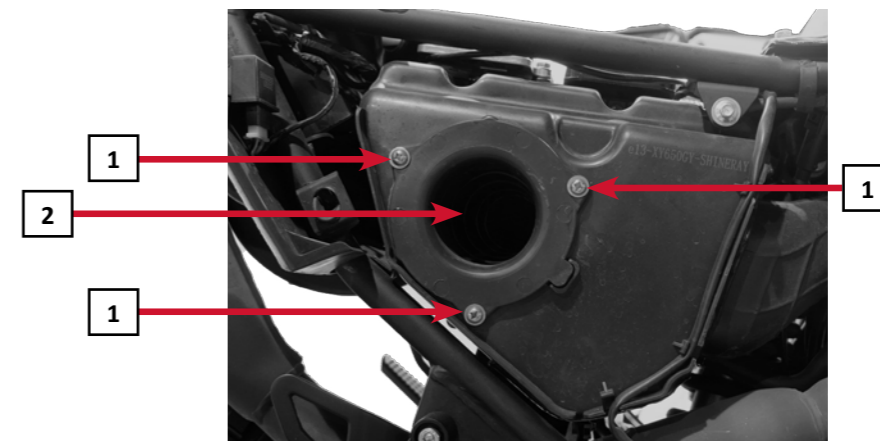

Caution

- **If the motorcycle is used in dusty areas, check and clean the air filter at intervals closer to those prescribed in the maintenance table.**
- **When cleaning the filter, check that it is not damaged; if necessary replace it.**
- **Never start the engine without first replacing the air filter: this could increase engine wear.**

Clean the foam filter as follows:

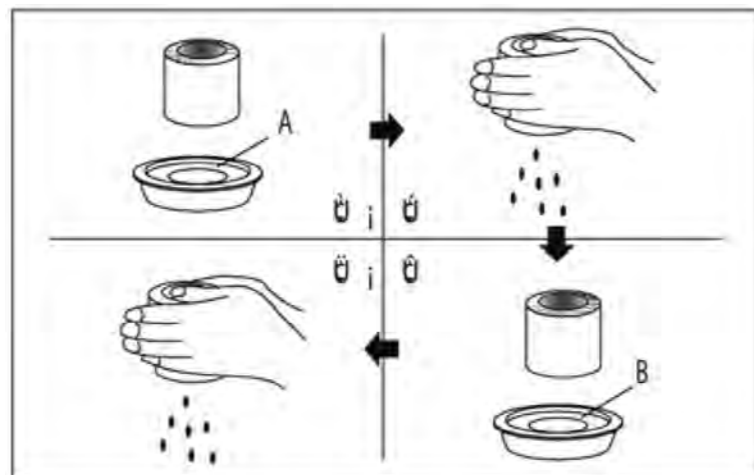

1. Fill a suitable size container with a non-combustible cleaning solution. Submerge the foam in the cleaning solution, then rinse it.

2. Squeeze the foam between the palms of the hands to remove the cleaning solution. Never twist the filter as this may damage it.

3. Dip the filter in the engine oil tank, then wring it out to remove the oil: the foam should be slightly damp.

IPONE reference: AIR FILTER CLEANER / AIR FILTER OIL

4. Replace the filter in reverse order. Make sure that the filter is correctly replaced and perfectly protected.

⚠ Caution

• Before and during cleaning, make sure that the filter is intact; if it shows any damage, replace it.

• Cleaning and replacing the air filter should be done more frequently if the vehicle is used in dusty areas.

Never start the engine without first replacing the air filter: this could aggravate engine wear.

The effectiveness of the air filter partly conditions the longevity of the engine, so it is essential to check its condition.

Injection

Your Mash motorcycle is equipped with an injection system (EFI) to optimize the air / fuel mixture. Prohibition and inability to adjust the injection system. Therefore, it is not possible and strictly forbidden to adjust the motorcycle's injection system. If the EFI warning light on the meter comes on, you must go to an authorized Mash dealer in order to carry out a diagnosis.

Adjusting the play of the throttle cable

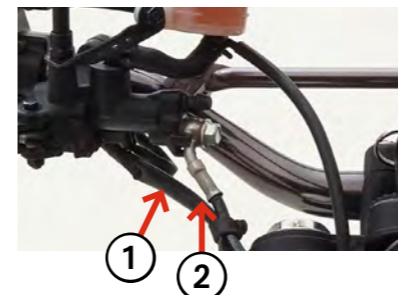

1. Contre-écrou 2. Ecrou de réglage

1. Loosen the lock nut.
2. Turn the nut so that the cable play is between 0.5 and 1.0 mm.
3. After adjustment, retighten the locknut.

⚠ Caution

When the throttle cable free play has been adjusted, check the throttle grip for proper operation. The setting will have no effect on the engine idle speed, and the handle will automatically return to the closed position.

Clutch adjustment (guard)

Clutch adjustment is made by adjusting the tension of the clutch cable. Before disengaging by pulling the clutch lever, the cable play measured at the clutch lever should normally be 10 mm. If the measured value is different, adjust as follows.



Loosen the nut (1) and turn the tension ring of the lever (2) fully clockwise. Unscrew the lock nut of the cable tension ring (5), before turning the ring (4) in one direction and then in the other until the play of the lever reaches approximately 4 mm. The lever adjustment ring (2) can optionally be used to fine-tune the adjustment. Once the adjustment has been made, retighten the locknut (1) and the ring (5), then wrap them with the rubber sleeve (3).

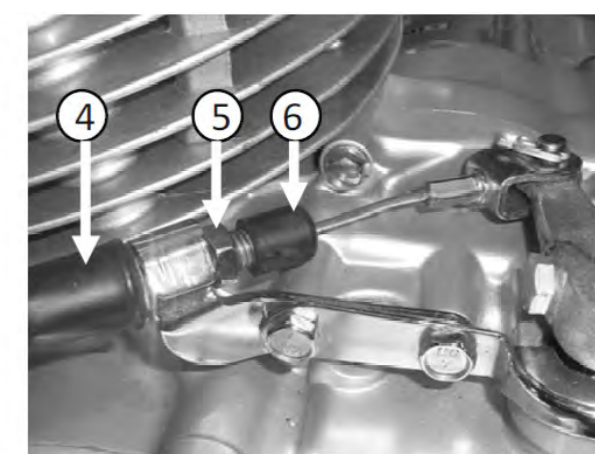

Adjusting the transmission chain

To adjust:

1. Secure the motorcycle on its side stand or center stand (if equipped).
2. Loosen the nut on the rear wheel axle.
3. Loosen the lock nut.
4. Turn the adjustment bolt left or right to achieve the desired adjustment.

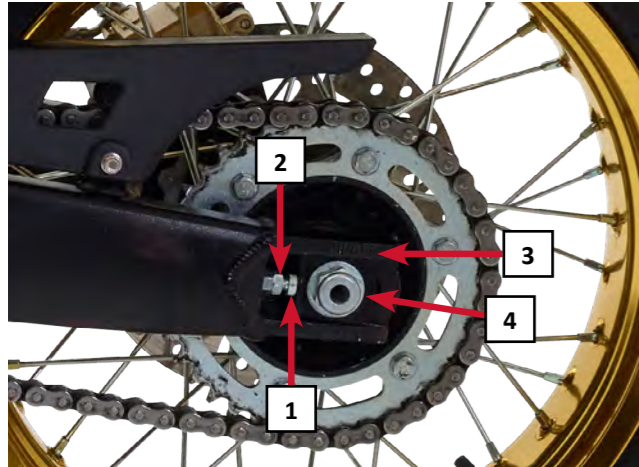

1. Adjustment bolt
2. Lock nut
3. Alignment mark
4. Rear wheel axle nut

Note: When installing a new chain, it is necessary to check the pinion and crown. It is advisable to replace the chain kit.

The tension of the drive chain should be adjusted every 1000 km so that the play is between 20 and 30 mm.

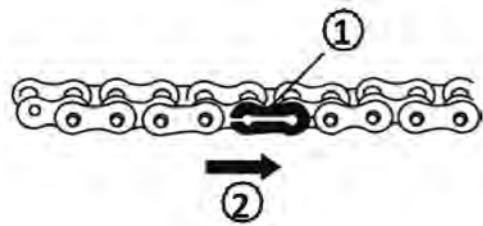
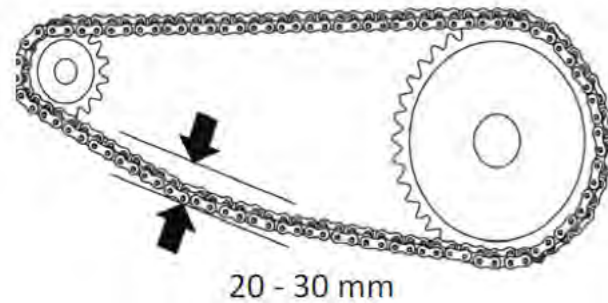

⚠ Caution
The closed (rounded) part of the chain quick release clip should face the direction of chain rotation.

1. Quick chain clip
2. Direction of rotation

Cleaning and lubricating the drive chain

The accumulation of dirt on the drive chain can worsen its wear and that of the sprockets. It is therefore strongly recommended to clean the chain every 1000 km using a cleaning solvent, then grease it with a special lubricant or engine oil.

Reference: IPONE: Chain Cleaner / X-TREM Chain Road.

Tires

Check the tire pressure and their tread after the first 1000 km, then every 3000 km. In addition to periodic checks, get in the habit of checking tire pressure from time to time to prolong tire life and ensure maximum safety.

Tire pressure

Insufficient pressure can worsen tire wear and affect vehicle stability: in particular, changes of direction can be more difficult. Conversely, excessive pressure, by reducing the contact surface between the tires and the road, increases the risk of skidding or even loss of control of the vehicle. Therefore, it is necessary for the tire pressure to remain within the specified limits. The tire pressure should be adjusted when cold, before driving.

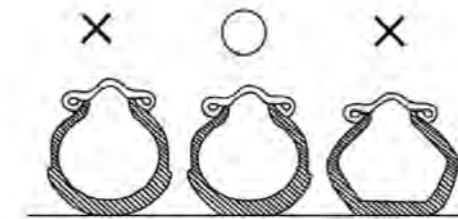

Pression X-Ride 650cc : Avant - 1,7 bar / Arrière - 1,9 bar

Tread Sculptures

Riding a motorcycle with worn tires compromises its stability and comes with an increased risk of loss of control. If the tread depth of the front wheel is not sufficient, it is advisable to have the tire replaced. This operation is also necessary for the rear tire if the depth of the rear wheel tread is not sufficient.

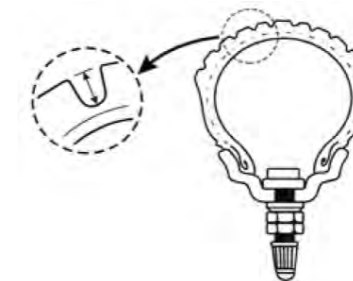

⚠ Warning

As the use of tires other than the standard models can cause problems, it is strongly recommended that you use tires identical to the original ones. Compliance with the recommended tire inflation pressure is essential, it directly determines the performance of the vehicle and driving safety. Check tire wear and pressure from time to time.

Storage and cleaning

Prolonged non-use of the motorcycle during winter or another season requires specific operations requiring suitable materials, equipment and techniques.

Motorcycle

If the motorcycle will not be used for an extended period of time, perform the following operations before storing it: Wash the motorcycle and stabilize it with its side stand on hard, level ground. Rotate the handlebars to the left and lock the steering. Remove the ignition key. Choose a location suitable for long-term storage for the safety of the two-wheeler. Before reusing it, carry out a complete inspection to verify the performance of all parts.

Fuel

Before immobilizing the motorcycle, empty the fuel tank: gasoline is indeed highly flammable, and can even become explosive under certain conditions. Never leave the motorcycle near a heat source. Never park it in a place where there are very flammable materials (grain, coal, cotton, etc.): the fuel in the tank could start a fire by coming into contact with the flames.

Tires

Inflate the tires to normal pressure. Keep their surface clean. Avoid prolonged exposure to direct sunlight or moisture. Avoid contacting the tires with corrosive solutions (acids, alkalis and oil).

Battery

In case of prolonged non-use, remove the battery and fully charge it before storing it in a safe place out of the reach of children. Then recharge it once a month in summer, once every two months in winter. If the battery is left in place for a long time, recharge it once a month.

Storage and its stages

If the motorcycle is equipped with a conventional battery, check the electrolyte level once a month. If the fluid level is low, quickly add distilled water to the upper mark. (Never use electrolyte or tap water)

Keep the battery clean at all times. There is a risk of corrosion in the event of electrolyte splashing on the vehicle body or on the battery terminals and wires. If this happens, rinse immediately with clean water and apply a layer of grease after drying.

A lack of power can cause difficulty starting, reduce the sound level of the horn and prevent the turn signals from functioning. Recharge the battery immediately for 15 to 20 hours. Note that prolonged storage of a discharged battery may damage it.

A battery has reached its maximum operating time if: its terminals are covered with a white deposit; it delivers low power; the electrolyte volume is less than the minimum mark and, in each of the above cases, if its performance cannot be restored after long-term storage, even after recharging.

Reuse after storage: the procedure

1. Thoroughly clean the motorcycle.

2. Remove the spark plug; press the starter to let the engine run for a few moments before reinstalling the spark plug.

3. Replace the battery. Note: Do not forget to connect the positive pole before the negative pole.

4. Inflate the tires to the pressure specified in the corresponding section of this manual.

5. Lubricate all the parts requiring it by proceeding as indicated in this manual.

6. Observe the instructions in "Pre-ride inspection" before setting off.

Cleaning

Frequent and regular cleaning is an essential part of maintaining your motorcycle. Exposure to natural elements (sea breeze, sea water, mud, dust, etc.) and to non-slip additives spread on the roads in winter, can be a source of vulnerability for the components of your motorcycle. Corrosion and rust can appear even on good quality parts. Proper maintenance and regular cleaning of your vehicle will not only prolong its original appearance, but also are essential in order to maintain warranty rights.

Precautions Before Cleaning

When the engine is cold, protect the exhaust outlet with suitable protection (example: plastic bag) to prevent water from entering inside.

Exposed electrical components should be covered with a plastic bag. Check that the lids and caps are correctly positioned.

Using a degreaser and a soft brush, remove any major stains that may be on the crankcase, making sure never to apply it to the gears, transmission chain, seals and wheel axles. . Rinsing of residues and degreaser will be done with water.

Cleaning :

Cleaners that are too acidic or aggressive are not recommended for washing the motorcycle. Particularly at the level of axles, bearings, levers, pivots, wheels and spokes. If, however, it is necessary to use it for stubborn stains, follow the instructions and application times for the product. We recommend that you spray these parts with an anti-corrosion product after rinsing with plenty of water.

Plastic parts and windshields (for equipped vehicles) should preferably be cleaned with water using a sponge or soft cloth. Only a mild detergent can be used if some plastic parts cannot be cleaned properly. Rinse the product used abundantly: poorly rinsed, it could damage the plastic parts. The use of all other products on plastic parts is strictly discouraged (thinner, solvent, gasoline, antifreeze, abrasive cleaner, etc.).

⚠ Caution

Special precautions: Do not use a high pressure cleaner or steam jet: Avoid directing the water jet near the following items: on-board instruments, brake cylinders and calipers, under the fuel tank, transmission chain, bearings steering column, gaskets, air box, wheel or swingarm bearings, all electrical components as well as air vents. Water infiltration could damage these elements.

After use under normal conditions:

Soak in lukewarm water mixed with a mild detergent using a soft sponge, then rinse thoroughly. A damp cloth placed for a few minutes on parts with more stubborn stains and insects, will loosen dirt gently.

After use in the rain, near the sea or on salty roads:

Clean the motorcycle with cold water and a mild detergent: do not use hot water, this will increase the corrosive action of the salt. Protect the vehicle from corrosion by spraying an anti-corrosion product on all metallic, chrome or nickel-plated surfaces.

After cleaning:

Dry body parts with a chamois leather or soft absorbent paper. After being dried with a disposable disposable cloth, the transmission chain should be lubricated with a specific lubricant to prevent it from rusting. It is advisable to scrub chrome or stainless steel parts (including the exhaust system) with a chrome cleaner. An anti-corrosion product should be sprayed on all metallic, chrome or nickel-plated surfaces. Lubricate the pivot pins, bolts and nuts. Apply wax to all painted parts.

⚠ Caution

Special precautions: Never use lubricating or greasy products on the braking elements. This could decrease braking efficiency and cause an accident.

Always use a specific degreaser for braking systems.

Copyright in this manual and its ultimate interpretation is ours. Under no circumstances may this document or any part of it be reproduced or cited without our prior written permission.

All information, descriptions, illustrations and specifications contained herein reflect the state of our knowledge at the time of publication. However, we reserve the right to modify this manual at any time in the event of improvements or other changes.

Product specifications and parameters are also subject to change without notice!

Product configuration and availability of spare parts may vary by country or region. For more information on this, please consult your local distributor!

**Local distributor :
MOTOMONDO
Lorentzlaan 14,
3401 MX IJsselstein
NETHERLANDS**

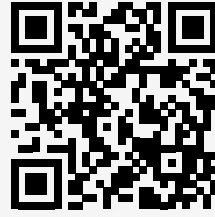

www.motomondo.com

Find your reseller



01/02/22

REJOIGNEZ-NOUS SUR LES RÉSEAUX SOCIAUX :



@mashmotors_benelux & mashmotors_uk



@mashmotorsbenelux & mash.motors.uk



@mash motors west europe